



# 3G/UMTS Towards mobile broadband and personal Internet

# A WHITE PAPER FROM THE UMTS FORUM

FEBRUARY 2005

This paper offers an overview of the current status of launches of 3G/UMTS networks, terminals and services, before examining the technology roadmap for 3G/UMTS and its relevance in the context of future mobile systems and services.

## Introduction

Just five years ago, the reality of 'mobile data' meant little more to real-world users than sending text messages or struggling to browse share prices and weather reports via a slow connection.

Today, however, customers are experiencing their first real taste of faster, user-friendly multimedia on the move. Notebook computers and PDAs equipped with mobile data cards or wireless network connectivity are a ubiquitous sight in every hotel lobby and airport lounge. Consumers can send picture messages to their friends' phones or download the latest games and polyphonic ringtones – and now, with the first wave of 3G/UMTS networks operational in Europe following Japan's early start, they can view news bulletins, sports highlights and music videos streamed to their mobile handset.

Hand in hand with the accelerating roll-out of high-speed 3G/UMTS cellular networks, the end-user experience continues to improve. Attractive, affordable handsets feature dramatically increased processing power and functionality compared with their antecedents of just a few years ago. At the same time, the provisioning of new services by mobile operators is becoming steadily more in tune with the needs of real customers. Users no longer have to spend hours struggling with an instruction book in order to configure their handset to browse the web or access e-mails – today it is a faster, more user-friendly experience. Tighter integration between the roles of handsets, networks and service provisioning has resulted in an 'out of the box' experience that finally lives up to customer expectations. The

unarguable result is increased usage, valuable new revenues from non-voice services and a strengthening of crucial brand-based relationships between mobile network operators and their customers. It would appear, therefore, that in exchange for incurring a significant investment risk – measuring over €100bn in licensing costs in Europe alone – mobile operators have positioned themselves to capitalise effectively on the long-term revenue possibilities that 3G/UMTS presents.

From its origins as a purely voice usage proposition for business users, mobile communications has come a long way. But, while the possibilities offered by 3G/UMTS are exciting, it is important to consider its longer term ramifications in a broader technological and market context. Thanks to the mushrooming presence of Wireless Local Area Network (WLAN) hotspots, mobile users already have a choice of complementary connection methods in low mobility or nomadic situations that has grown with the advent of other technologies including WiMax/Flash OFDM and Ultra Wide Band (UWB)/Broadband Wireless Access (BWA). This range of options will grow still further. At the same time, the ubiquity of broadband connectivity to fixed networks in homes and offices has raised the bar in terms of user expectations. Mobile access to corporate resources and multimedia services at speeds comparable to a traditional dial-up connection is no longer 'good enough'. Increasingly accustomed to enjoying low cost connectivity at megabit speeds and beyond, customers may one day balk at paying a premium for comparable data rates and quality of service in the wireless space, despite the obvious added value that mobility affords.

## Contents

- 1 Introduction
- 3 Section 1: To the first 16 million customers... and beyond  
Perspectives on 3G/UMTS launches, terminals and services
- 3 What is 3G/UMTS? And why is it important?
- 5 A compelling business case
- 6 First experiences: a market perspective
- 7 At your service: portals drive consumer uptake
- 8 3G/UMTS terminals: enabling the mass market
- 8 Pricing Schemes: From Pay As You Consume to flat-rate... new services, new charging models
- 8 Courting the customer: exploring new operator approaches to offering 3G/UMTS services
- 9 Lessons learned
- 9 Evolutionary trends
- 11 Section 2: Standardisation - creating a stable environment for deploying 3G/UMTS mobile broadband services
- 11 Radio Access Network Developments
- 11 Air Interface Developments
- 12 Core Network Developments
- 13 Push-to-Talk (PTT/PoC)
- 13 Interworking with WLAN
- 13 Security and Privacy
- 14 Section 3: A Look to the Future
- 15 Mid-Term Evolution
- 16 Long-Term Evolution
- 17 Glossary
- 18 Annex - 3GPP and Technical Specifications for 3G/UMTS

Rapid take-up of 3G/UMTS services indicates that the IT and telecommunications industries are now at a critical 'tipping point'. Balancing projected growth in demand for mobile data services on the one hand with a perceived commoditisation of bandwidth on the other, all industry players – including fixed and mobile operators as well as device manufacturers, content providers and regulators – must examine traditional business models and anticipate tomorrow's commercial landscape with pragmatism and flexibility.

With more than 1.2 billion subscribers between them, operators of today's GSM mobile networks have something of a head-start in the race to hang on to customers while giving them more of what they already pay for. The entry of new players may not

destroy the value of this market – indeed, it may significantly increase it overall – but it will certainly change the rules of engagement. While tomorrow's mobile landscape will be more complex than today's, however, it is clear that the mainstream technology of 3G/UMTS and its clearly charted evolution will maintain an instrumental role in defining the value proposition for hundreds of millions of mobile multimedia users globally. This will particularly be the case while WLAN and other low mobility/nomadic technologies remain unproven in their ability to generate strong, sustainable revenues for operators. In this paper, we survey the current state of play with 3G/UMTS roll-out before examining in more detail the technology roadmap that will pave the way to realising tomorrow's 'portable Internet' and the central role of 3G/UMTS in enabling this exciting future.

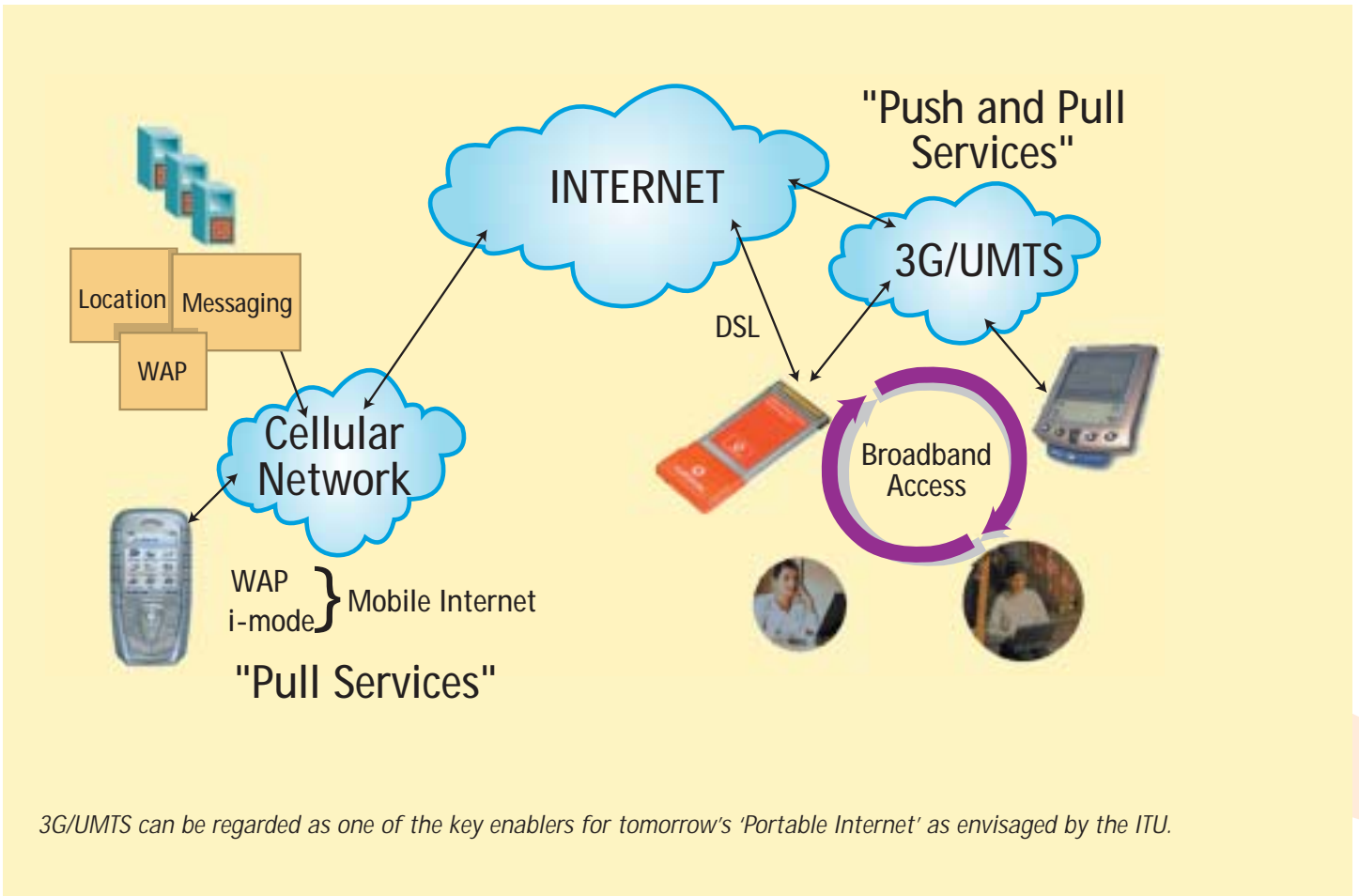

*3G/UMTS can be regarded as one of the key enablers for tomorrow's 'Portable Internet' as envisaged by the ITU.*



# Section 1: To the first 16 million customers... and beyond

## Perspectives on 3G/UMTS launches, terminals and services

By the end of 2004, there were more than 16 million 3G/UMTS customers subscribing to 60 networks based on WCDMA technology in 25 countries – and many more networks were either in advanced testing or in pre-commercial launch phase, with a total of more than 125 licences awarded to a mixture of incumbent operators and new players.

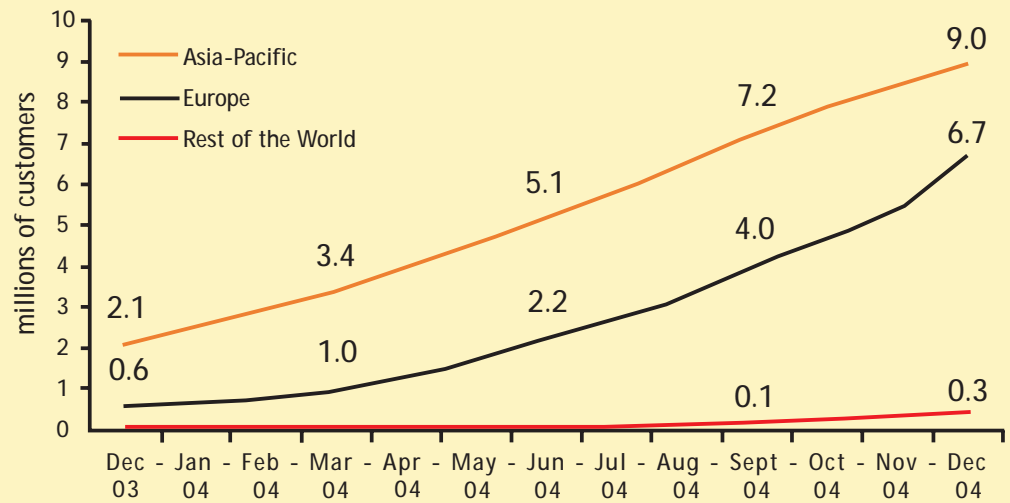

*A steadily increasing number of commercial networks plus a greater choice of attractive handsets contributed to rapid 3G/UMTS subscriber growth during the second half of 2004.*

### 3G/UMTS: The natural evolutionary choice for more than a billion mobile customers

With over 1.2 billion subscribers to over 600 networks in more than 200 countries worldwide, GSM is overwhelmingly the most popular mobile technology globally. GSM subscribers enjoy many benefits, from seamless automatic international roaming with other GSM networks to the widest choice of attractive, feature-rich terminals at a wide range of price

points. GSM's unsurpassed global footprint also enables mobile operators and equipment manufacturers to enjoy major economies of scale as they migrate their 2G customer base to 3G/UMTS services by re-using significant portions of their GSM core networks and back-end systems.

### What is 3G/UMTS? And why is it important?

Building on current investments in GSM/GPRS, 3G/UMTS offers mobile operators significant capacity and broadband capabilities to support greater numbers of voice and data customers – especially in urban centres – plus higher data rates at lower incremental cost than 2G.

The choice of eight out of the world's ten biggest operators who have been awarded licenses to launch 3G services, UMTS represents the natural evolutionary route from 2G to 3G for more than 90% of the world's mobile users – spanning 1.2 billion GSM customers as well as subscribers to second generation TDMA and PDC networks.

Making use of radio spectrum in bands identified by the ITU for Third Generation IMT-2000 mobile services and subsequently

licensed to operators, 3G/UMTS uses a 5 MHz channel carrier width to deliver significantly higher data rates and increased capacity compared with second generation networks. This 5 MHz channel carrier provides optimum use of radio resources, especially for operators who have been granted large, contiguous blocks of spectrum – typically ranging from 2x10 MHz up to 2x20 MHz – to reduce the cost of deploying 3G networks. This contrasts with the 1.25 MHz channel carrier width specified for the CDMA2000 system that was developed initially to serve North American mobile markets with more limited access to large, contiguous blocks of radio spectrum than operators in Western Europe. This means that 3G/UMTS offers greater cost efficiencies in terms of carrying network traffic than other mobile technologies, allowing operators to support larger numbers of simultaneous users and offer greater data speeds.



## IMT-2000/UMTS Spectrum Allocations after WRC-2000

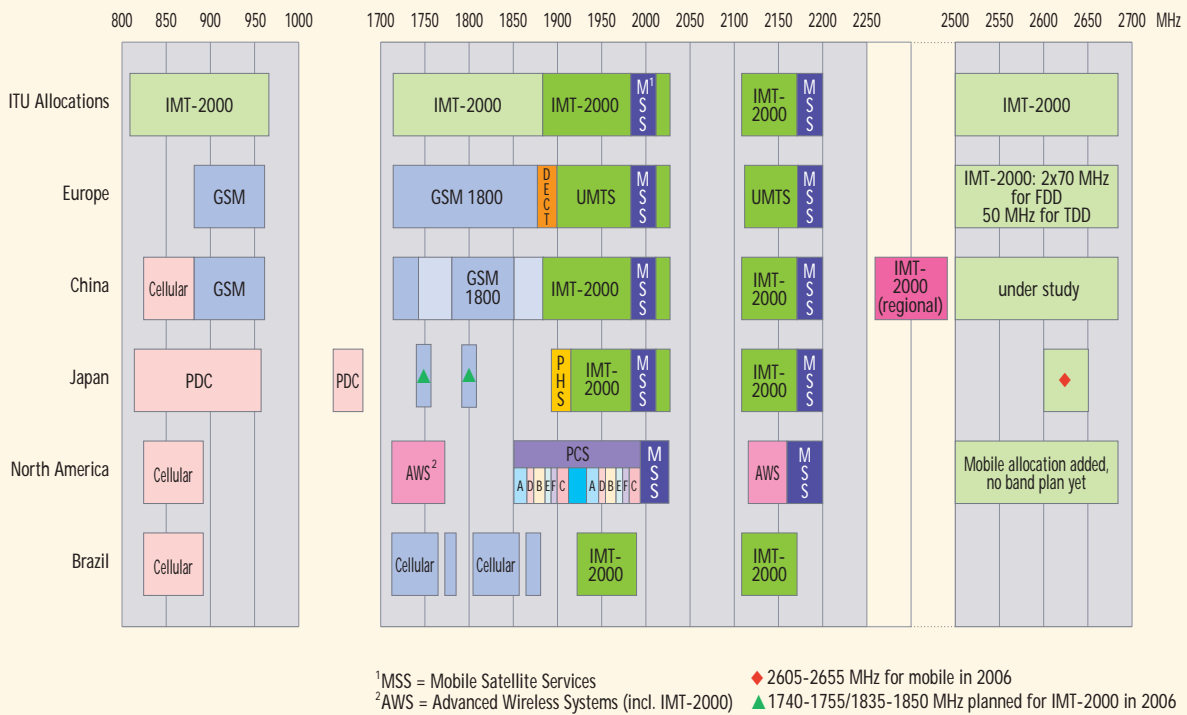

3G/UMTS networks make use of globally harmonised radio spectrum in licensed frequency bands identified by the ITU for Third Generation IMT-2000 mobile services.

Crucially, 3G/UMTS has been specified as an integrated solution for mobile voice and data with wide area coverage. Universally standardised via the Third Generation Partnership Project ([www.3gpp.org](http://www.3gpp.org)) and using globally harmonised spectrum in paired and unpaired bands, 3G/UMTS in its initial phase offers theoretical bit rates of up to 384 kbps in high mobility situations, rising as high as 2 Mbps in stationary/nomadic user environments. Symmetry between uplink and downlink data rates when using paired (FDD) spectrum also means that 3G/UMTS is ideally suited for applications such as real-time video telephony – in contrast with other technologies such as ADSL where there is a pronounced asymmetry between uplink and downlink throughput rates.

Ongoing technical work within 3GPP will see further increases in throughput speeds of the WCDMA Radio Access Network (RAN). High Speed Downlink Packet Access (HSDPA) and High Speed Uplink Packet Access (HSUPA) technologies – discussed in Section 2 of this paper – are already standardised and are undergoing network trials with operators in the Far East and North America. Promising theoretical downlink speeds as high as 14.4 Mbps (and respectively 5.8 Mbps uplink), these technologies will play an instrumental role in positioning 3G/UMTS as a key enabler for true 'mobile broadband'. Offering data transmission speeds of the same order of magnitude as today's Ethernet-based networks that are a ubiquitous feature of the fixed-line environment, 3G/UMTS will offer enterprise customers and consumers all the benefits of broadband connectivity whilst on the move.

Specified and implemented as an end-to-end mobile system, 3G/UMTS also features the additional benefits of automatic international roaming plus integral security and billing functions, allowing operators to migrate from 2G to 3G while retaining many of their existing back-office systems. Offering increased

capacity and speed at lower incremental cost compared with second generation mobile systems, 3G/UMTS gives operators the flexibility to introduce new multimedia services to business users and consumers while providing an enhanced user experience. This in turn provides the opportunity for operators to build on the brand-based relationships they already enjoy with their customers – and drive new revenue opportunities by encouraging additional traffic, stimulating new usage patterns and strengthening customer loyalty.

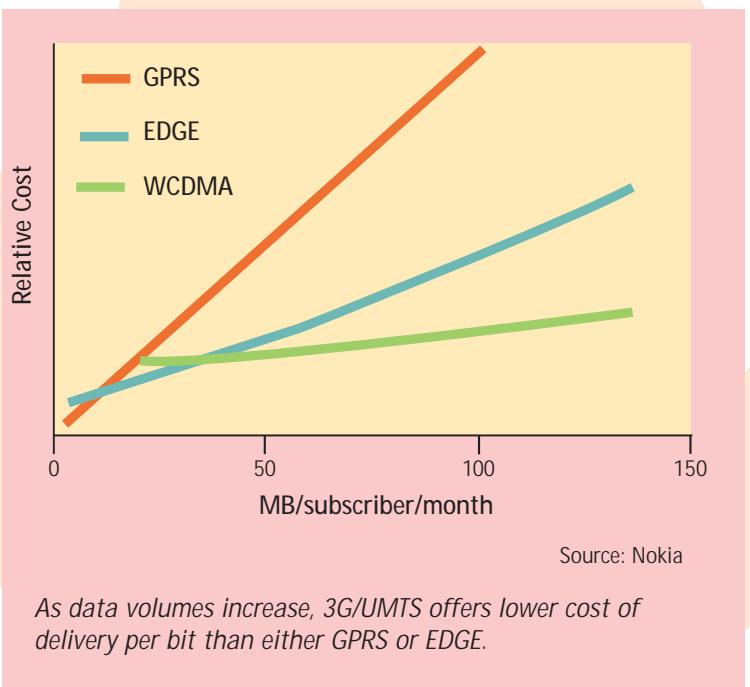

## A compelling business case

### 3G Operator Evolution Options

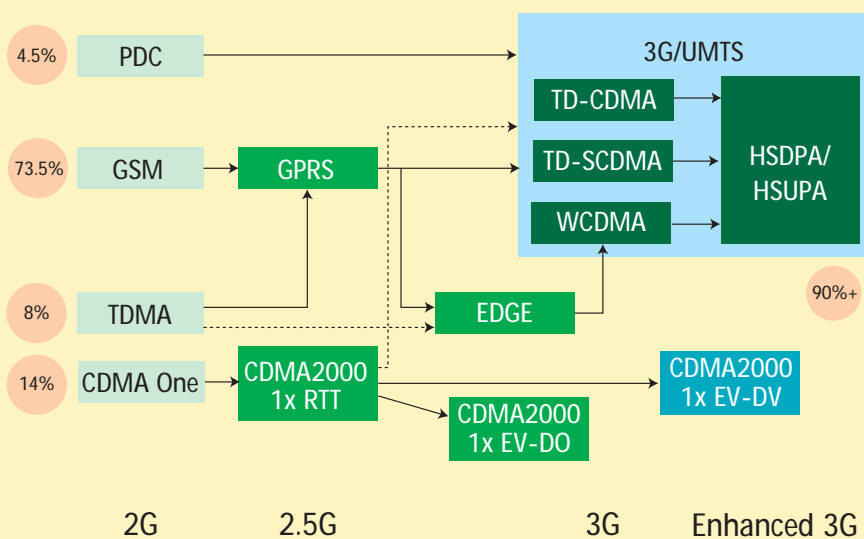

3G/UMTS offers a logical migratory path from second generation networks for more than 90% of the world's mobile subscribers.

With further long-term growth in mobile traffic forecast over the next 10-20 years, mobile operators are looking to enhance the experience of their customers while driving higher demand for value-added services and a corresponding increase in revenues.

As has already been noted, using fresh radio resources with far higher spectral efficiency than second generation technologies, 3G/UMTS gives operators the opportunity to:

- support more subscribers – especially in urban centres where existing 2G networks are facing limitations in their ability to meet growing demand for voice and data services
- offer data speeds up to 10 times higher than GPRS in order to enable new multimedia services such as videotelephony.

Designed as a high capacity, wide area system, 3G/UMTS reduces the real cost of delivery per bit and thus brings significant cost gains per traffic unit, particularly in high-traffic environments. Aside from increases in speed and capacity, 3G/UMTS affords a smooth evolutionary path to 3G while allowing 2G operators to retain and re-use many of their existing investments in cell sites, core network infrastructure and supporting IT systems. These cost benefits are particularly notable for operators of second generation GSM networks, who can re-use many legacy elements of their existing GSM infrastructure to deliver a cost-effective network optimisation opportunity. As an illustration, some 65% of the costs of deploying a 3G/UMTS network represent the radio infrastructure, with 35% assigned to the development of core network, services platform and IT systems. GSM legacy enables elements of cost optimisation including:

- national and international roaming, enabling step-by-step investment
- re-use of existing sites and site sharing
- dual-mode mobile stations
- same core network platform and IT systems
- step-by-step development of service platforms

With the chance to reduce the proportion of investments in relation to total turnover and consequently strengthen their free cash flows, GSM operators can reduce their 3G/UMTS

deployment costs by up to 50% compared with greenfield operators. Significantly lowering the capital cost per bit of delivering voice and mobile data compared with GSM, GPRS and EDGE, 3G/UMTS provides higher capacities and bit-rates at lowest cost. It is clear that 3G/UMTS will generate further new revenues, in particular when all players – spanning subscribers, operators and content providers – have assimilated this new technology.

It is important to maintain a sense of pragmatic realism when forecasting the total impact of 3G/UMTS on operators' revenues over the next ten or even twenty years. It is interesting, however, to observe that operators such as NTT DoCoMo, that led the way with the world's first fully commercialised WCDMA network, have observed a significant increase in their non-voice revenues. DoCoMo has confirmed that its average revenue per user (ARPU) increased from just over USD 71 in the first quarter of 2003 to USD 94 in the same quarter of 2004. Of this total, non-voice revenues grew from 25 to 33 per cent in the same period, demonstrating that usage of 'i-mode' and other services has grown as NTT DoCoMo migrates customers from its second generation personal digital cellular (PDC) network to its 3G Freedom of Multimedia Access (FOMA) network.

Two interesting observations can be made from the NTT DoCoMo experience: firstly, that non-voice data services, and customer migration to 3G/UMTS increase data ARPUs, and secondly that customers are responding positively to more attractive terminals with lower weight, better screens, improved multimedia capabilities and longer battery life. The prognosis for other operators is positive: give customers access to appealing handsets and a wide variety of attractively priced, easy to use services... and they will come to you quickly.

While it is important to be cautious when looking into the crystal ball, one thing is clear. With non-voice revenues ranging between 13 and 21 per cent of monthly ARPU in Europe – and between just 2 and 5 per cent in Latin America – there is enormous potential for operators to grow revenues significantly as they migrate from 2G and 2.5G to 3G.

## First experiences: a market perspective

Thanks largely to NTT DoCoMo's early lead with the launch of its FOMA WCDMA network in 2001 – the world's first – Japan accounts for 52.5% of the global 3G/UMTS market [SOFRECOM, December 2004] with over 8.4 million customers on DoCoMo and Vodafone KK's networks, while Europe contributes a further 42% to the global WCDMA base. The remainder – about 5.5% of global 3G/UMTS subscriptions – represents the relatively small number of networks launched to date in Australia, South Korea, Hong Kong, the United States and the Middle East.

Hutchison has been the earliest player to introduce 3G/UMTS services as a greenfield operator with an international footprint under the '3' brand. With networks launched commercially in Australia, Austria, Denmark, Hong Kong, Ireland, Israel, Italy, Sweden and the United Kingdom, by December 2004 Hutchison had gained approximately 6.8 million customers.

As the total number of 3G/UMTS networks has increased significantly over the last few months, it is instructive to take a selective look at some of the launches that have shaped this fast-growing market since the beginning of 2004. In the UK, where Hutchison launched its consumer-focused offering under the '3' brand in Q1 2003, Vodafone was the first incumbent to launch a 3G data card service for its business customers. Introduced in April 2004, the Vodafone Mobile Connect 3G/GPRS data card provides users high-speed access to the Internet and corporate intranet from laptop computers, including roaming capability in selected other territories. Orange followed with the launch of its 'Mobile Office Card' solution when its 3G network in the United Kingdom went live in mid-July 2004. At launch, network coverage was estimated to reach 66% of the UK population. Users of the Mobile Office Card in the UK are also able to roam on the networks of Orange's FreeMove alliance partners in Italy, Germany and Spain, as well as on the operator's own network in France. T-Mobile UK also launched its own business-oriented multimedia package in a similar timeframe.

In France, operator SFR initially launched commercial services in May 2004 to business clients via PC card in three key cities – Paris, Lyon and Lille – preceding the introduction of consumer services in November 2004. Orange also adopted a measured approach to 3G roll-out, starting off with a PC card commercial service in September 2004, followed by a full consumer launch in early December 2004 with 40% population coverage.

In Germany, T-Mobile launched 3G services on its UMTS network at the end of April 2004. Vodafone had introduced consumer 3G services by May (having already started with a business-targeted 3G data card service), offering its German customers the ability to video call with users on other networks of its subsidiaries in Italy, Portugal, the Netherlands and Spain. O2 Germany meanwhile kicked off with a data card service, with the delivery of handsets coming later, as well as an upgraded, more robust mobile portal and bundled WLAN access, aimed at generating increased revenues from 3G users. By July, e-plus had also launched its data offering to business users.

Italy has already emerged as a marketplace that was quick to embrace the appeal of 3G/UMTS, as demonstrated by Tre's confirmation that it passed the 1 million customer milestone in March 2004, just 16 months after commercial launch. Half way through this year, Italian subscribers to Tre had already downloaded almost 3 million video and multimedia news clips, as well as 10 million music content downloads and 300,000 downloaded games. The operator reported in July that its

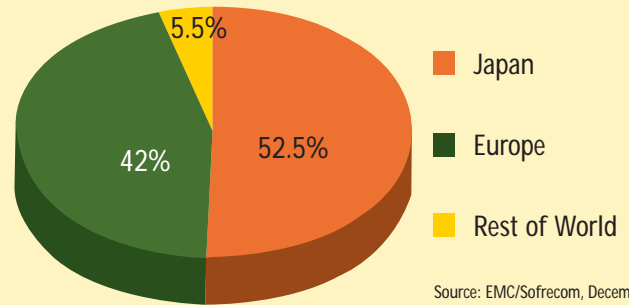

*By early 2005, 3G/UMTS networks based on WCDMA technology had attracted 16 million subscribers, with 42% of these in Europe.*

customers had also made 120 million minutes of videocalls – a clear signal that 3G/UMTS has the ability to stimulate usage and drive new service adoption. During May, Vodafone Italy launched to businesses and consumers at the same time that TIM introduced its 'TIM Turbo' mixed UMTS/EDGE offering.

In Spain, Vodafone and Telefonica Moviles (TEM) have both launched business and consumer-friendly services, while Xfera's expected launch after Amena will bring the Spanish network count to four by early 2005. Elsewhere in Europe, Euro 2004 football host Portugal saw service launches from TMN, Vodafone and Optimus. And incidentally, Vodafone Portugal was the first operator to provide its customers with 3G/UMTS data services roaming in Spain, the Netherlands, the United Kingdom, Italy and Japan. Elsewhere in Europe, the first half of 2004 also witnessed new launches in Austria, Belgium, Ireland, The Netherlands and Sweden.

In North America, the picture of course differs significantly from the one in Asia and Europe. Against the backdrop of rapid migration from TDMA and CDMA to GSM throughout the Americas, Cingular has run UMTS/WCDMA network trials in Atlanta, operating in the 1900 MHz spectrum, including early testing of HSDPA – a technology that promises far greater speeds to deliver the vision of true broadband mobile. Cingular's tests are also of great interest since the operator has indicated that support for Voice over Internet Protocol (VoIP) services will be an intrinsic part of its strategy in the future.

The roll-out of 3G/UMTS services in the United States continued with the announcement by AT&T Wireless in September 2004 that it had extended its 3G/UMTS service to Dallas and San Diego. According to the announcement, the company's wireless broadband service gives customers the ability to use a handset, personal digital assistant (PDA) or laptop to receive streaming audio and video services; create and share video clips; experience richer and more visually compelling content; and connect to critical business information, in most areas throughout these cities. In July 2004, AT&T Wireless began offering customers in Detroit, Phoenix, San Francisco and Seattle broadband mobile services when it launched its first 3G/UMTS network in the United States.

## At your service: portals drive consumer uptake

Operators are already introducing a new wave of 3G services enabled by the additional speed and capacity that WCDMA access technology offers through its spectral efficiency and use of fresh radio resources. Apart from a seductive blend of services already familiar to mobile customers – from Java games and ringtones to news, sports, entertainment and information services – 3G/UMTS is readily distinguished from 2G/2.5G by its ability to support new video-based services that can offer a superior user experience compared with GPRS and indeed EDGE. These range from video multimedia messaging (MMS), videotelephony and multi-party videoconferencing to downloadable video clips, video streaming and live television.

Mobile portals have already been a key driver for the mass-market uptake of 2G mobile services in many world regions. This has been particularly evident in Asian territories such as Japan, where operators such as NTT DoCoMo have introduced 3G-specific services and content – including video-based entertainment – via its i-mode portal, while maintaining compatibility with existing 2G services. Usage has been further stimulated by the adoption of ‘all you can eat’ flat rate data tariffs that encourage user experimentation and exploration of new services. Furthermore, a similar home page to access 2G and 3G i-mode services ensures a minimal learning curve for 3G users already familiar with DoCoMo’s 2G portal offering.

DoCoMo’s strategy – teaming a friendly user experience with extensive network coverage (99.7% POP by June 2004) and the availability of affordable, attractive handsets with longer battery life – has resulted in continuing subscriber growth as well as strengthened usage and ARPU. Elsewhere in Asia, strong marketing of dedicated 3G portals – themed as content ‘channels’ including mobile TV, video on demand, music downloads and mobile messaging – has also resulted in a tangible increase in usage and data ARPU for Korean operators.

Reflecting the success of this model in driving consumer demand for 3G/UMTS, portals will also play a vital role in European operators’ strategies for stimulating consumer adoption of 3G/UMTS. To date, Hutchison’s operations in several countries have followed a portal strategy focusing on video content, accessed via a dedicated key on the handset. Multimedia content is structured in Hutchison’s portal according to thematic channels, with specially-tailored content provided through partnerships with broadcasters and other media owners. Video clips – typically lasting a few minutes each – can be streamed or downloaded for later viewing according to the user’s preference. Hutchison offers a choice of tariffing options, including subscription to ‘bundled’ data services; pay-per-download; and add-on subscriptions offering unlimited flat-rate access to multimedia services.

Vodafone is another operator with an extensive European presence that has already targeted consumers with its Live! 2G portal. Vodafone is now introducing 3G Live! across its operations, integrating 3G services – spanning mobile TV and video on demand – into its existing portal structure.

Orange, meanwhile, has associated the launch of its consumer/residential 3G/UMTS offering with four key services, namely video calling, video MMS, mobile television and mobile PC card access. Its Orange World portal has also been enhanced with new content, featuring nine thematic channels for the French market and personalised infotainment services in the UK.

While it appears that the majority of other operators will adopt a similar model, launch activities have been relatively low profile in advance of mass availability of suitable handsets offering compatibility with portal services. It is also clear that the majority of operators’ consumer strategies will be characterised by a smooth integration of 3G services into existing 2G portals to ensure user familiarity, backed by increased choice of compatible handsets and strong marketing support.

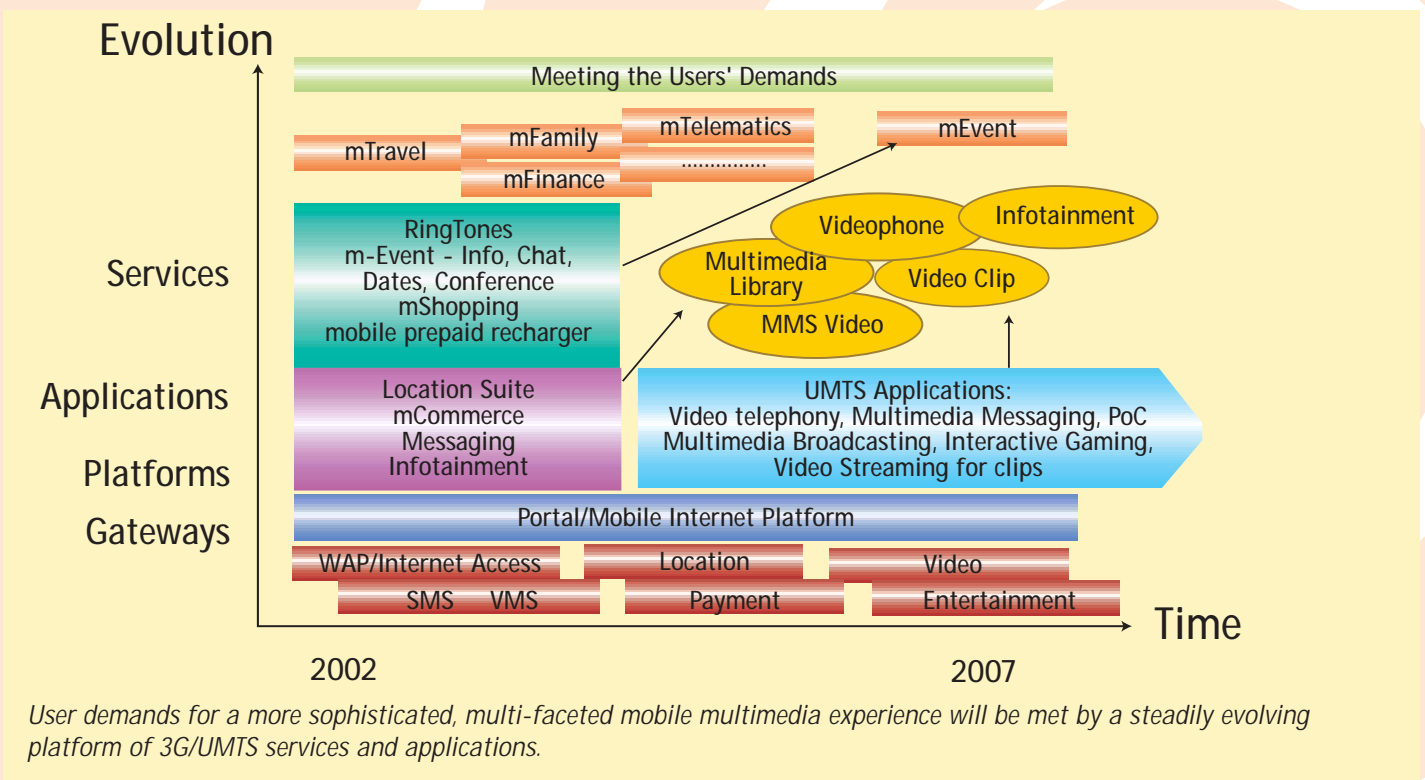

## 3G/UMTS terminals: enabling the mass market

A wide choice of high-performance terminals is needed to experience and enjoy these new services. By early 2005, over 100 different WCDMA terminal designs – spanning handheld terminals and PC datacard models – had already been launched or announced by American, Asian and European manufacturers.

The performance and market appeal of earliest WCDMA terminals was restricted by factors including limited battery life, larger size and greater weight than their 2G peers. This situation has changed markedly, however. Latest designs now available to support mass-market consumer launches by 3G/UMTS operators compete head-to-head with the best available 2G phones in terms of performance, functionality, ease of use and aesthetic appeal. As well as support for 3G-specific services such as videotelephony, current models offer consumer-friendly features such as 64,000 colour screens and integrated MP3 stereo music playback capabilities. Reflecting the importance of digital imaging with consumers, multi-megapixel camera phones are now available from several manufacturers.

The role of the terminal itself as a key driver for the mass market adoption of 3G/UMTS services has been well recognised by mobile operators, and indeed the majority of global players have co-ordinated their launch plans to coincide with the widespread availability of a choice of appealing, attractively priced terminals. This observation also explains the strategies of many operators who preceded consumer launches with commercial offerings to business customers based on a PC card. While allowing operators to fine-tune the performance of their WCDMA networks under 'real world' conditions, it has also provided the opportunity to gain experience of tariffing and usage patterns in advance of the widespread availability of consumer-friendly terminals.

## Pricing Schemes: From Pay As You Consume to flat-rate... new services, new charging models

By offering additional network capacity at lower incremental cost than 2G, 3G/UMTS gives operators more flexibility on pricing for voice telephony. Operators are currently experimenting with a mix of pre-paid and post-paid tariff plans in order to gauge customer demand for new services. In particular, 'soft' launches to limited numbers of customers have allowed operators and consumers to explore new pricing models for 3G/UMTS.

Some operators have opted for converged pricing between GSM, GPRS, 3G/UMTS and WLAN, with new tariffs only for innovative services such as 'live' television and videotelephony. Others, in contrast, have used commercial launches to experiment with radically new pricing models. The first wave of 3G/UMTS customers in Europe and Asian markets has already been able to choose from a range of pre-paid and contract-based tariff options, as operators assess market demand while evaluating new strategies that will drive additional revenues. Some players – such as Hutchison 3 – have secured a foothold in the market through offers based on low-cost voice calls and text.

Indeed, the bulk of NTT DoCoMo's FOMA additions come from its existing PDC customer base, who have been lured by attractive,

*By early 2005 more than 100 3G/UMTS devices had been launched or announced.*



feature-packed handsets and new discount data packages. NTT DoCoMo has also opened up its network to foreign subscribers on 21 international partner networks in 19 countries (in April 2004) and is signalling its clear intention to make 3G services accessible to as many customers as possible. FOMA customers can select from a range of tariffs including flat-rate packet schemes in return for a service line-up which includes:

- mode (e-mail messages up to 10,000 characters, sound and image file attachments), i-motion (e-mail delivery of sound, video and still images)
- Videophone and V-LIVE real-time video streaming
- High bit-rate packet data with Multi-Access (simultaneous voice plus packet data transmission)
- mode FeliCa 'wallet' for mobile payments

FOMA coverage now extends to almost 100% of the Japanese population, served by more than 13,000 cell sites. This evolution, however, represents a steady customer shift from 2G and 2.5G rather than a 'big bang'. The evidence of this is clear in markets like Japan, where NTT DoCoMo's 2G customer base is migrating to FOMA at an increasing rate. With more than 7 million customers at the end of October 2004 on the FOMA network, this represents an average of more than 500 customers per site: a positive indication that 3G can deliver capacity and quality of service in 'real-world' conditions.

## Courting the customer: exploring new operator approaches to offering 3G/UMTS services

The earlier part of 2004 saw a number of operators – including several of the major players – introduce PC-only access to their WCDMA networks ahead of large-scale availability of high-performance, attractively priced terminals. With connectivity via a mobile PC data card rather than a handheld terminal, this allowed operators to evaluate and fine-tune the performance of their networks under 'real-world' conditions. It has also given business customers the opportunity to experience the speed and performance of 3G/UMTS for themselves, with a range of pricing plans that bundle WCDMA/GPRS/GSM datacards with volume-based usage charges.

Many operators are seeing the service possibilities that 3G enables in the context of an overall mobility proposition to their customers. For users wishing to browse the Web, download from the Web or access corporate resources while away from the office, 3G offers mobility with wide area coverage, integral security and international roaming. In contrast, WLAN technology can present a potential complement by offering high-speed Internet connectivity in nomadic situations where 'hot-spot' access is provided. Some European operators are already taking steps to make this process transparent to the user, integrating billing for mobile and WiFi usage together with connection management software that simplifies the task of configuring a notebook PC to use both methods of wireless connectivity. Examples of operators that have already seen the potential of this seamless mix of network access options are T-Mobile and O2. T-Mobile has launched its 3G/UMTS service in the United Kingdom, allowing anyone with a WiFi-enabled notebook and PC card to access UMTS, GPRS and WLAN within the same tariff plan. O2 has introduced a similar offering for UK customers, providing access to cellular and WiFi networks via a data card supported by easy-to-use Connection Manager software.

The strategy of several operators to bundle 3G/UMTS connectivity with WiFi access presents a number of advantages. By giving end-users the freedom to select their preferred connection method while on the move, operators can 'own' that customer for longer periods of time with the potential to increase the value of their relationship. Furthermore, providing seamless WiFi access allows operators to strengthen relationships with their data customers while coverage of their 3G/UMTS networks increases.

Other operators, meanwhile, are pursuing a strategy of seamless extension of their mobile networks by adding other fixed or nomadic extensions (e.g. Unlicensed Mobile Access – UMA) to their cellular core infrastructure, enabling voice and data services over new access technology.

As a number of operators have come to recognise, many customers will neither know nor care what method of connection they are using at any given moment. All that matters to them is the quality, cost and value of the service provided to them under the brand name of their chosen provider.

## Lessons learned

- Market growth for 3G/UMTS depends on all elements – including network coverage and quality, terminals, services and customer care functions – being successfully in place.
- High licensing costs in some territories have imposed a major financial burden on operators to deploy 3G/UMTS. Further licensing should thus be conducted in a way that creates a fertile market rather than placing undue constraints on operators to launch services.
- Large-scale availability of attractive, high-performance, competitively priced terminals is a key enabler for market acceptance of 3G/UMTS.
- Operators must offer services to customers that provide a smooth evolution from their current 2G experience.
- Appealing data and multimedia services are demonstrated to increase operator ARPUs. There is clear evidence from the market that customers appreciate and make use of 3G/UMTS when they experience it for themselves!
- Operators must assess the role of other complementary technologies (WiFi, WiMAX etc) and future enhancements to 3G/UMTS as part of their overall service proposition to business customers and consumers.

Complementing these observations, The UMTS Forum has also made a series of recommendations to national administrations in other world regions that have not yet completed their own licensing processes. Drawing on the experiences already gained in markets where 3G/UMTS has launched, these recommendations encourage a process of flexible dialogue with administrations that allows operators to meet end-user demand for cost-effective services in a realistic timeframe:

- License in good time – and at reasonable cost – within globally harmonised IMT-2000 spectrum bands for a reasonable number of operators
- Set realistic roll-out and coverage obligations (quick coverage of urban areas)
- Allow co-operation between operators in rural areas (network sharing, national roaming)
- Simplify the process of site acquisition and agree on harmonised environmental conditions

## Evolutionary trends

Since NTT DoCoMo launched FOMA – the world's first commercial WCDMA network – in 2001, global numbers of WCDMA subscribers have risen faster than those of GSM second generation technology during the corresponding period. This growth to date, however, should be seen in the context of significant challenges that have faced mobile operators, equipment manufacturers and content providers to ready their offerings. Since the majority of 3G/UMTS licenses were awarded by 2001, the industry has invested significant resources to address issues that include:

- acquisition of suitable cell sites and speed of network roll-out to meet coverage targets mandated by regulators in relation with environmental constraints
- widespread availability of affordable handsets achieving levels of functionality, weight, size and battery life to meet the expectations of mass-market users
- interoperability of 3G services with networks and terminals from different providers, plus smooth handover between 2G and 3G networks
- creation, adaption and aggregation of new and existing multimedia content for delivery via handheld devices
- market education to promote awareness of 3G services

By successfully addressing these key drivers and inhibiting factors, the mobile industry has already made considerable progress in enhancing the appeal of 3G/UMTS to business users and consumers alike. As a result, 2004 can be rightly regarded as the year of the true widescale commercialisation of 3G/UMTS. From this exciting start, however, mobile operators are already readying themselves to meet the new challenges of evolving their initial 3G/UMTS offerings to realise the long-term vision of true mobile broadband and the 'portable Internet' that this technology will enable.



But what about the next chapter of the story? Just as fixed telecommunications networks are evolving from their Public Switched Telephone Network (PSTN) roots to Next Generation Networks based on an all-Internet Protocol (IP) structure, the foundations are being laid for a similar transformation in the mobile space with the IP Multimedia Subsystem (IMS). Bringing IP transport in the Core Network, as well as in the Radio Access Network, IMS will enable end-to-end services, service integration, instant messaging and, in particular, presence and real-time simultaneous conversational services. While this represents a major part of the core network investment for operators, thanks to IMS, in a few years' time, we will see mobile infrastructures becoming progressively end-to-end IP environments. The result? Operators will have far greater opportunities to host, deliver, manage and bill for an exciting new tier of advanced multimedia services, with the possibility of supporting multiple services simultaneously over the same connection.

In parallel with this evolution from voice-centric origins to a packet-based model, mobile networks must also offer an order of magnitude increase in data speeds to meet the needs of the modern enterprise. With specifications for HSDPA extending the data throughput capabilities of WCDMA to multi-megabit speeds, a standardised platform is already in place that will see 3G/UMTS delivering the long-held dream of true broadband mobility. With access at Ethernet speeds to e-mail, the Web and corporate applications, businesses will be able to give their workers even more freedom to work wherever and whenever they need to, effectively unconstrained by bandwidth limitations. For consumers, the change is expected to be equally dramatic: with HSDPA – and HSUPA for similar improvements in uplink performance – 3G/UMTS will usher in a new wave of content-rich applications.

We hear news of other exciting developments that promise even faster, cheaper wireless broadband access in the future. The ceaseless pace of technological research is inevitable, and indeed it is the work of manufacturers, operators and standardisation bodies that has put us in the position we are today. It is easy to be distracted by the promise of multi-megabit per second transmission speeds, but it is important not to lose sight of the tangible benefits that 3G is already delivering and is expected to continue to deliver. As 3G matures in terms of its service capabilities, and becomes more affordable and accessible to a greater proportion of the world's population, it has the potential to improve the personal connectivity of a billion people or more during the course of the next decade – just as GSM has already done. The priority for us all in the global telecommunication community must be to ensure that the benefits 3G offers are harnessed to improve the social and economic conditions of as many of the world's citizens as possible in the years – and decades – to come.



As will be discussed in the following sections of this paper, an analysis of the true long-term impact of 3G/UMTS must be considered in the context of several other factors. These include:

- The technological roadmap for enhancing the speed, capacity and functional capabilities of 3G/UMTS networks
- Projected market demand for mobile services
- The complementary – or potentially disruptive – effects of other wireless technologies outside the IMT-2000 family that will provide other methods for end-users to access voice and data resources in nomadic situations
- Possible changes in the regulatory or legislative environment that may influence operators' long-term business plans
- Spectrum challenges linked to the growing multimedia mobile traffic, in the framework of harmonised IMT-2000 frequency bands and extended allocation at the World Radio Conference 2007.

### WRC-07: why is it important?

The UMTS Forum believes that globally harmonised frequency bands are of major importance for the successful development of mobile systems, and in particular for global roaming and to reduce equipment costs through economies of scale. European and worldwide harmonisation of mobile communication systems has been achieved through the GSM standard and is being continued with 3G/UMTS, which is a natural evolution from GSM.

The World Radiocommunication Conference in 2007 (WRC-07) will consider on its agenda "frequency related matters for the future development of IMT-2000 and systems beyond IMT-2000", with the aim of achieving global harmonisation while avoiding unco-ordinated regional developments.

The UMTS Forum is performing studies on long term market evolution which could be used to estimate the frequency requirements to answer capacity needs for the future development of IMT-2000 and systems beyond IMT-2000. New frequencies should be estimated and identified according to the market needs. The spectrum below 6 GHz is the most appropriate to answer capacity needs for IMT-2000 evolutions and systems beyond, around the year 2015.

Results of studies undertaken by The UMTS Forum also confirm the clear benefit of providing UMTS/IMT-2000 coverage at 470-600 MHz compared with the 2 GHz band and also to 900 MHz band in large areas of low population density. The benefit comes in terms of the lower number of base station sites and is of the order of saving two out of three, even three out of every four base station sites to be deployed (i.e. cost savings of 66 to 75%). The economic impact on operators' investments makes it possible to pass on benefits to the end-users, too. The UMTS Forum believes that there is a need for harmonised mobile spectrum in the band 470-600 MHz in order to provide better coverage for UMTS/IMT-2000 services in a more cost effective way, particularly in large areas of low population density.

## Section 2: Standardisation - creating a stable environment for deploying 3G/UMTS mobile broadband services

While most WCDMA networks operational today adhere to the set of standards referred to as 'Release 99', commercial deployments of Release 5 of the 3GPP specification for 3G/UMTS are imminent and represent a significant step in the evolution of 3G/UMTS. Release 5 standards enhance network performance by introducing IP transport into the radio access network, increase data speeds by an order of magnitude through the HSDPA feature, and specify the IMS in the core network that allows the tight integration of real-time and non-real-time services, opening up the prospect of convergence of mobile broadband networks with the Internet world.

These innovations will be further enhanced with a range of new features in addition to those already contained in Release 5, creating Release 6, which is under finalisation for early 2005. Enhancements focus on increasing network and spectrum efficiency, implementing Quality of Service (QoS), new service possibilities and interworking procedures with complementary technologies.

The portfolio of technology developments encapsulated in 3GPP Releases 5 and 6 (see Annex, page 18) will deliver a comprehensive and stable environment for the deployment of 3G mobile broadband services.

### Radio Access Network Developments

Major progress in the evolution of the Radio Access Network (RAN) architecture was made in Release 5 through the introduction of IP at the transport layer as an alternative to Asynchronous Transfer Mode (ATM). The use of IP as a transport protocol in the RAN represents the first step towards the implementation of an end-to-end IP network.

Further architectural evolution of the RAN in 3G/UMTS is focusing on technologies that improve radio performance and transport layer utilisation. A key aim is to reduce delays for users. This will result in a redistribution of some RAN functionalities between existing nodes, bringing radio-related protocols closer to the radio interface.

The overriding goal is to create a transport layer where QoS requirements such as delay and jitter are determined by actual end-user service requirements instead of the requirements of the radio interface. This will have a significant effect on transport costs as the volume of non-real-time IP traffic increases.

### Air Interface Developments

HSDPA, as the next step in the evolution of the 3GPP air interface, was introduced in Release 5 to realise high speed data rates on the downlink. It provides integrated voice on a dedicated channel, and high speed data on a downlink shared channel on the same carrier, that allows data rates of up to 14.4 Mbps, translating into average user data rates in the region of 3 Mbps. HSDPA will be primarily deployed for dense urban and indoor coverage.

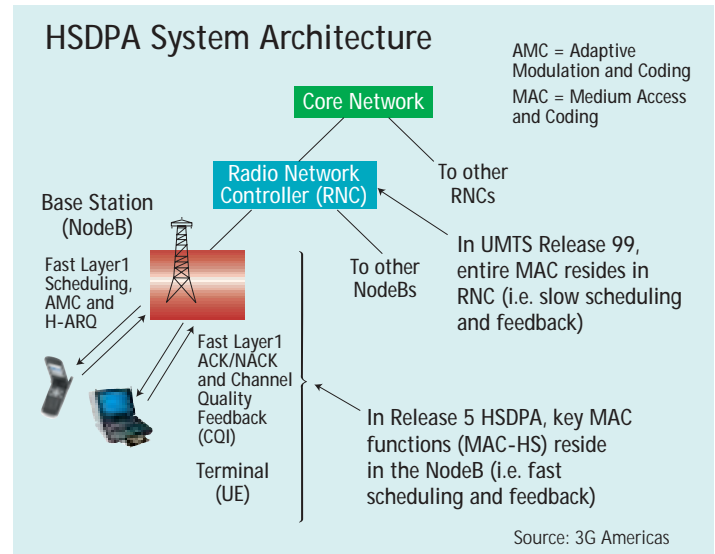

In effect, HSDPA provides a 'fat-pipe' shared channel for users experiencing good radio conditions, increasing the spectral efficiency by using higher order modulation schemes. Rate adjustment rather than power control is used to compensate for varying radio conditions, a more efficient means of allocating radio resources. Users' experience will range from throughput as per previous Releases when in poor radio connections to up to the maximum as indicated above with good quality radio connections.

HSDPA implementation includes advanced techniques such as adaptive modulation and coding, and advanced re-transmission mechanisms and can be applied to either FDD or TDD modes. It can significantly increase user data rates but only for 'best effort' services such as Internet access or file download. In a first step, HSDPA is not intended as a solution for real-time services that require guaranteed QoS and also places heavy demands on terminals – initial deployments are expected to be confined to 3G data cards on laptops.

Nevertheless, enhancements to radio link performance are likely within Release 6 that will further significantly increase the benefits of HSDPA. Release 6 will also address the use of dedicated transport channels to improve performance in the uplink, with HSUPA speed up to 5.8 Mbps.

As the deployment of IP-based services increases there will be growing demand to improve coverage and throughput as well as reduce the delay of the uplink. Enhanced uplink performance will be of particular benefit for background, interactive and streaming-based traffic such as video-clips, multimedia, e-mail, telematics, gaming and video-streaming.

Techniques for enhancing uplink performance focus on protocols that allow rapid retransmission of erroneously received data, improving QoS by reducing the number of retransmissions and the associated delays, and more responsive uplink scheduling and data rate control by implementing NodeB (3G base station) rather than Radio Network Controller (RNC) controlled scheduling.

Enhanced uplink and downlink transport channels optimise the use of the radio resources. In the future, air interfaces designed for the delivery of even higher data rates are likely to utilise Orthogonal Frequency Division Multiplex (OFDM) techniques that are beginning to find wide application as a result of advances in digital signal processing capabilities. OFDM promises a higher efficiency on the air interface due to its inherent orthogonality which reduces intracell interference.

OFDM is the basis for digital audio broadcast and some fixed wire transmission techniques such as xDSL and is the basis for most of the IEEE 802.xx family of standards.

## Core Network Developments

The integration of mobile communications and Internet technologies is one of the far-reaching consequences of IMS, the IP Multimedia Subsystem. IMS addresses the creation and deployment of IP-based multimedia services in 3G mobile networks. It specifies IP-based transport for real-time as well as non-real-time services and introduces a multimedia call model enabling communications sessions to be established between multiple users and devices. All IMS entities are located in the core network.

IMS is radically different from earlier communications systems in that it allows multiple services to be carried on a single bearer channel. This facilitates the integration of real-time and non-real-time services within a single session and provides the capability for services to interact with each other. Efficient handling of resources is a key feature as the network can satisfy the QoS requirements of data flows from the different media components within a service.

The IMS architecture separates the service layer from the network layer, facilitating interoperability between 3G mobile networks and fixed networks such as the PSTN and the Internet. Service creation within IMS becomes similar to the Internet environment, open to a wide community of developers. IMS services include person-to-person real-time services (such as voice telephony) over packet-switched networks, gradually removing the necessity for a circuit-switched domain in 3G networks.

Moving real-time services from the circuit-switched domain to the packet-switched domain means that all services will eventually be delivered via one integrated network rather than two overlaid networks. Voice services will become just one application within the IMS environment.

The Session Initiation Protocol (SIP) is used within the 3GPP-defined IMS system for multimedia call control. IMS has also been adopted by 3GPP2 (the 3G CDMA2000 standardisation body), allowing harmonisation of SIP at the services level. SIP is also at the heart of the Internet, and standards for interworking with non-IMS IP networks will be a key part of Release 6. IMS is therefore set to provide a common multimedia services platform for the mobile world that will ultimately enable seamless service provision across mobile and fixed networks.

## IMS: the benefits to operators and users

Capability	Comments
Real-time, Person-to-person IP-Based (eg voice)	Once development work is completed, IMS will include the ability to transmit real-time, person-to-person services such as voice over the IP network.
Real-time and non-Real-time Media Interaction	IMS allows for the interaction of both real-time and non-real-time media types in a single session.
Multimedia Call Model	IMS allows simultaneously use of <ul style="list-style-type: none"> <li>• Multiple media services within a single session</li> <li>• Multiple sessions between multiple users and devices</li> </ul> For the end-user this allows the interaction and integration of services.
Network Interoperability	IMS includes the ability to exchange real-time person-to-person communications, including presence and location information, between IMS and other IP networks.

*The IP Multimedia Subsystem (IMS) enables mobile operators to leverage Internet applications, services and protocols to offers an enhanced person-to-person communications experience.*

## Push-to-Talk (PTT/PoC)

'Push-to-talk' services are a typical example of the functionality enabled by the introduction of IMS. In push-to-talk (PTT) services, the talk is one way at a time. Communication is initiated by pressing and holding a button rather than by dialling and can be overheard by other members of a defined user group. It is similar to 'two-way radio' or 'walkie talkie' systems but without the limitations of restricted coverage.

Implementing PTT services over 2G circuit-switched cellular networks is complex, time consuming and costly, as every switch, base station and terminal needs to be upgraded. But implementing PTT services over 3G networks enhanced with the emerging IMS standards is easy – the use of SIP allows the service to be implemented in a single application server.

Standardisation work on PTT over cellular (PoC) is currently in progress. Clearly there are advantages in enabling PTT services across networks rather than restricting members of a user group to subscribers of a single network operator. In the meantime, many operators and manufacturers are exploring ways to utilise SIP call processing to offer PTT services today over the packet-switched domains in 2.5G and 3G mobile networks rather than wait until standards-compliant systems are commercially available.

Great care has to be taken with such interim implementations. PTT is somewhat unusual in the way that the quality and reliability of the service is intimately linked to the underlying network technology. For implementations to be successful, PTT needs to have the characteristics of a real-time, conversational style service in which people can speak and receive responses in less than a second, allowing normal two-way dialogue to occur.

3G IMS systems will be able to support real-time, conversational services over the packet domain. But 2.5G networks do not support QoS, and the latency characteristics of packet-switched networks can cause problems. When delays across the network are large, then PTT services can behave like store and forward messaging systems. The ability to conduct 'normal' conversations is lost and the service risks disappointing users.

PTT is not a replacement for mobile voice. It represents a new type of usage in closed user groups not previously captured by mobile phone providers, enabling more convenient ways to relay information within the group than by making mobile phone calls. It has similarities with SMS instant messaging services but with the added advantages of immediacy of connection and simplicity of operation. PTT services underscore the value of presence.

## Interworking with WLAN

Enhancements of 3G technologies will lead to improvements in cost and performance, and HSDPA/HSUPA will considerably improve the mobility/bandwidth performance of the 3G mobile networks. But a single air interface cannot be optimised to deliver high data rates and high spectral efficiency in both high mobility and low mobility requirements. Mobility and bandwidth are, to a certain extent, a trade off. Enhancing the performance of 3G systems simultaneously toward higher bandwidth and higher mobility is best achieved through a hybrid concept of different air interface modules serving specific market segments.

WLAN technologies such as WiFi are candidate air interface technologies for the nomadic or portable low mobility environment. Complementing and/or integrating these technologies with 3G can be an attractive option for network operators. A single subscription capability combining 3G in the wide area with WLAN service within hotspots would provide optimised and ubiquitous broadband coverage to mobile data users and deliver a competitive advantage to network operators.

The robust authentication, authorisation, accounting and billing principles embedded in the 3GPP specifications provide a solid basis for integrated solutions that deliver services across various technologies. Specification work on integrating WLAN into 3G systems is proceeding on a staged basis with an initial emphasis on common billing and customer care, 3GPP-based system access control and charging, and access to 3G packet-switched services from the WLAN.

The principles established for 3G/WLAN interworking are being adopted in standardisation activities targeted at the specification of next generation networks in a converged mobile-fixed environment.

## Security and Privacy

The deployment of 3G aligned with the continuing development of the Internet means that network operators are increasingly acting as providers of content services. That role carries obligations and responsibilities in the area of consumer protection. Ensuring security and privacy for users in data as well as voice transactions is a crucial but complex topic requiring co-operation across a number of different organisations.

Internet users are already being bombarded with spam, attacked by viruses and exposed to pornography. Protective measures are necessary to prevent such issues hindering growth in the 3G environment which has additional complications arising from the nature of mobile networks. Mobile devices and services are intensely personal; they become part of a person's identity and users do not always want that identity to be revealed. Network operators are the guardians not only of a user's identity but also of their profile – the interests, activities and patterns of behaviour that characterise the individual. Mobile operators hold information on the communications activities of users, their interest in different types of content, and on their physical locations at specific times. These all give rise to user protection issues.

Building and maintaining trust between users of 3G services and the network operator requires careful consideration and deployment of capabilities that safeguard confidential information about the user. Capabilities are required to safeguard personal data, identity and location information. Users require defences against unsolicited communications as well as virus attacks. They require mechanisms for controlling access to inappropriate content.

Systems based on 3GPP standards are well placed to address these issues. Authorisation and authentication capabilities tightly integrated within the 3GPP standards provide many of the necessary tools. SIM/USIM card functionality is an important factor in generating a trusted environment for the secure delivery of services. The broad range of issues involved in the provision of security and privacy protection for consumers is being addressed in a collaborative effort between 3GPP, the Liberty Alliance Project and the Open Mobile Alliance.

## Section 3: A Look to the Future

"A new concept of the ubiquitous network society is being developed, with government and industry working together to help realise it. These new technologies will transform the way we live our lives."

- Yoshio Utsumi, Secretary-General, International Telecommunication Union, September 2004

The portfolio of technology developments encapsulated in 3GPP Release 6 will deliver a comprehensive and stable environment for the deployment of 3G mobile broadband services. But what lies beyond? Is there a continuing roadmap for 3G/UMTS?

The telecommunications environment of tomorrow might be very different from that of today. Some changes will be evolutionary. Other developments could be revolutionary in their impact. Predictions of disruptive or subversive technologies are proliferating. Planning for such an inherently unpredictable future raises exciting challenges.

The needs of voice service users have been well served by the co-existence of fixed and mobile network domains. More recently, the addition of data and multimedia services has introduced the concept of nomadic or portable access. But the boundaries between fixed, portable and mobile domains are blurring with the inexorable shift to an all-IP environment. Combined services across fixed, portable and mobile network domains are starting to appear. In a very few years the traditional distinction between mobile and fixed operators could become blurred or even disappear.

The potential implications are profound. Lower cost voice services and almost unlimited bandwidth could become more prevalent over the next decade. The convergence of communications, IT and media services – long anticipated but persistently elusive – is attracting renewed attention, from both technology and regulatory perspectives.

Up until now, cellular technologies have evolved through the addition of more and more system capabilities and enhancements. Further enhancements are in the pipeline. But in the future, operators are likely to deploy a mix of access technologies incorporating cellular, WLAN, digital broadcast and wireline. Interoperability and interworking will become a crucial factor determining the success of new business models; they will no longer be characterised by a strong dependency on the underlying network infrastructure.

Future systems are envisaged as an evolution and convergence of mobile and wireless communication systems and IP technologies. They are expected to offer a multitude of seamless services over a variety of access technologies. **The underlying shift is from a network-centric to a user-centric approach.**

Some regulatory bodies are already embracing this approach, bringing communications, broadcast and media regulation under one roof. The traditional technology based 'silo' regime in which different access technologies are treated as separate, self-contained industries, seems doomed. In the future, delivery mechanisms could well be regulated in one way and services in another.

Adapting to changes of such magnitude is never easy. The telecommunications industry, characterised by high capex and long lead times, is particularly vulnerable to disruptive business models and subversive technologies. Technology migration paths

cannot always balance future capabilities against the constraints of legacy systems. The pace of change cannot always be managed to avoid disruption of service to users and to protect legacy investments.

It is fashionable to talk about the rapid pace of technological development. But that can be misleading. In reality, timescales for the development of new communications technologies tend to be long – from concept to commercialisation often requires years if not decades. While it is possible for disruptive technologies to emerge overnight, most breakthroughs are rarely spontaneous events. They are usually the end product of years of effort; it is the precise timing of that end product that is often unpredictable.

Problems are caused less by the sudden emergence of a disruptive technology than the fact that no-one saw it coming or appreciated its implications. Technologies are not so much disruptive as subversive. Voice over IP (VoIP), initially dismissed as a niche application, has been under steady development for over a decade. While it is not able to provide full mobility, WiMAX – currently being touted in some quarters as an alternative technology to 3G – started life in IEEE 802.16 in 1998, over six years ago.

### Comparative assessment of data rates and mobility

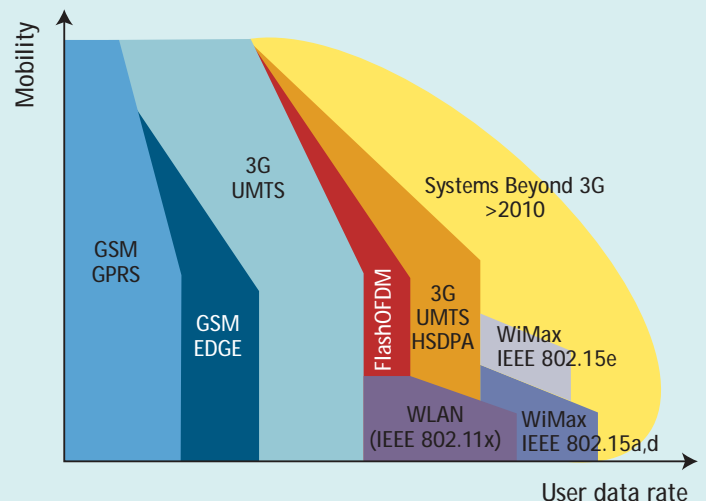

*In contrast with WLAN/WiFi and WiMAX systems built on the 802.11 and 802.15 families of standards, 3G/UMTS and its enhancements offer users high data rates with the added benefit of full mobility.*

The timings and effects of geo-political and socio-economic factors are rather more difficult to predict and interpret. They also impact the evolution of 3G/UMTS – recent examples are the disruption to business models resulting from licence auction fees and the dotcom collapse – but are inherently difficult to incorporate in evolutionary roadmaps.

## Mid-Term Evolution

The initial goal of 3G/UMTS – enabling **any time, anywhere** access to **multimedia** services – has already been achieved with the current releases of the standard.

Enhancements to the standard are in progress for release over the next five years. The next goal for 3G/UMTS can be described as enabling **optimal any time, anywhere** access to **multimedia** services. This will be achieved through an evolutionary roadmap designed to embrace the transition from a network-centric to a user-centric environment.

There are three dimensions to the 'optimal' concept.

1. Optimal implies enhanced performance. Scarce resources such as spectrum have to be utilised in the most efficient fashion possible. Performance enhancing technologies deliver cost effective services with guaranteed QoS to accommodate evolving business models and user requirements.
2. Optimal implies seamless service provision over a variety of access technologies. It reflects the emerging trend towards convergence. Services will increasingly be delivered over the access technology most appropriate to user requirements and circumstances.
3. Optimal implies user-centric service provisioning. It recognises that services are not just about connectivity but also about content and context. Service characteristics will match user needs for personalisation and security.

Enhanced performance focuses on increasing spectrum and bandwidth efficiency, acknowledging that continuous radio coverage may not be necessary to meet some service requirements. It delivers higher capacity for network operators and higher data rates for users. Within the next ten years, it is likely that user data rates in the mobile, fixed and portable environments will converge to around 100 Mbps, although the cost-performance characteristics of the different access networks will be very different.

Services will be delivered seamlessly and transparently to users over the most appropriate access network. The future may be a hybrid one, taking advantage of a variety of access technologies optimised for specific combinations of mobility and data rates, rather than a new 'next generation' global standard. There may not be one single network but a hierarchy of networks with 3G/UMTS complemented by other access technologies.

A common QoS-enabled IP core network could well be the engine of that hybrid future. Service delivery over the core network could well be based on the mobile IMS platform. The entire mobile multimedia world of tomorrow – both GSM-evolved and CDMA-evolved networks – will be IMS-based. The adoption of SIP in this end-to-end IP environment allows applications and services to be supported seamlessly across all networks, fixed as well as mobile – SIP is also at the heart of the Internet.

Evolution of the Internet itself could well be a determining factor for the implementation of optimal access solutions. Today's Internet has yet to match the standard of the PSTN,

## Upgrading to IMS

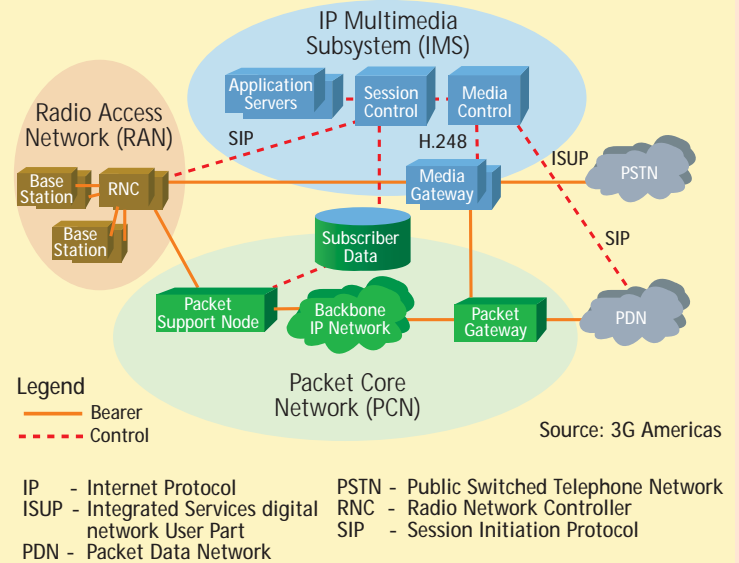

*Upgrading to IMS separates radio access, transport and control elements, with the IMS handling control of applications, control of sessions and media conversion*

delivering assured performance and security as well as ubiquitous connectivity. It is still predominantly an insecure, unreliable, best effort environment. While performance standards and QoS are absent from the Internet environment, the vision of ubiquitous multimedia services will remain unfulfilled.

The suitability of IMS as the platform for convergence is reinforced by the security and reliability features that are tightly integrated within the 3G/UMTS standards. These provide an unrivalled ability to create personalised services within a trusted environment.

The evolutionary roadmap for 3G/UMTS is in place and could have significant implications. Enabling optimal access opens the way for genuine convergence of the mobile and fixed worlds based on IMS as the multimedia services platform. Work on fixed IMS standardisation for next generation networks is already in progress in a collaborative effort between 3GPP and ETSI TC TISPAN (a combination of the previous working groups of TC SPAN and EP TIPHON – Telecommunications and Internet Protocol Harmonisation Over Networks).

A wide variety of technologies is being harnessed to deliver optimal access. Advanced modulation and coding schemes, adaptive antennas, spectrum sharing techniques and new multiple access schemes for the radio interface will enhance performance by improving spectrum and bandwidth efficiency. Concepts developed for interworking with local area networks are being extended to personal area networks and fixed networks to enable true access independence. Extensions of ad hoc networking concepts are behind the development of multihop architectures that can enhance capacity and reduce infrastructure deployment costs. Reconfigurable architectures and software defined radio techniques promise to realise the potential of terminals as general purpose programmable platforms. And the development of common service platforms with open architectures will enable user-centric service provisioning in a secure, trusted environment.

## Long-Term Evolution

The mid-term evolutionary goal for 3G/UMTS enabling **optimal, any time, anywhere** access to **multimedia** services is already in progress and addresses current trends in the telecommunications sector.

For the longer term – beyond the next five years – predicting technological capabilities and the impact of geo-political and socio-economic developments can only ever be a speculative exercise. Plausible scenarios can be developed, but which, if any, of those scenarios will materialise is purely a matter for conjecture.

It is inappropriate, therefore, to pursue a single technology or evolutionary roadmap for the longer term. A flexible approach is required in which a variety of routes is explored, learning and leveraging from each other.

Future applications and services could well be substantially different from those of today. Some will demand entirely new solutions rather than enhancements of current technologies. Such complementary technology solutions – including radically new wireless access technologies and radio interfaces – are expected to be required for deployment in some countries around 2015.

Although the long term is inherently unpredictable, one major challenge facing the mobile telecommunications industry is quite clear. It has been succinctly, if optimistically, expressed in ITU-R Recommendation M.1645 on the overall objectives of systems beyond IMT-2000. "It is envisaged that, by the year 2020, potentially the whole population of the world could have access to advanced mobile communications devices, subject to, amongst other considerations, favourable cost structures being achieved."

This challenge could even be interpreted as a new form of universal service obligation. Responding to that challenge, the long-term evolutionary goal for 3G/UMTS would become: **enabling universal, optimal, any time, anywhere access to multimedia services.**

A major emphasis on increasing the accessibility of communication services is undoubtedly a worthwhile goal to pursue as the mobile industry matures. It will require a focus on new issues that will inevitably result in fundamental changes within the sector. The process of identifying and addressing some of these new issues has already begun, reflecting a transformation within the industry from a largely reactive to a more proactive approach.

- A mobile user population of over 1.5 billion in a world of some 6.2 billion people is a stupendous achievement. But delivering communications to many underserved communities cannot be achieved by an extension of existing business models and processes. The mobile industry is currently geared to an ARPU expectation of around \$2 a day. A large proportion of the underserved populations have total incomes of less than \$2 a day. The digital divide is broad and deep and will require innovative approaches if it is to be bridged.

Developing and deploying technologies, regulatory regimes and business models to enable sustainable service provision to vast areas of coverage with low ARPU is a major long term challenge for the industry.



- Penetration in developed nations may be high but usage and usability of services remain low in some sectors of the population. The disabled and the elderly represent significant but poorly served market sectors. Indeed they are often further disadvantaged by the latest technologies and services. Adopting inclusive design concepts rather than relying on assistive technologies, accepting the principle that accessibility should be a design concern rather than an afterthought, has proved successful in many industries, yet has been largely ignored to date by the mobile communications industry.

Developing and deploying technologies, regulatory regimes and business models to produce systems with embedded intelligence able to adapt to the requirements of individual users is a major long term challenge for the industry.

- The shift from connectivity to the delivery of content and context-aware services brings obligations as well as opportunities. The mobile industry can no longer remain aloof to content. Protection against spam, fraud and access to inappropriate content are issues that have not yet been satisfactorily addressed in the Internet environment. Questions of privacy, intellectual property rights and security remain to be resolved. The traditional geographically bounded concepts of policing are ineffective in a global, borderless, networked world.

Developing and deploying technologies, regulatory regimes and business models to provide a secure and reliable trusted environment is a major long term challenge for the industry.

- Today's mobile systems have largely been developed within Western Europe and North America and targeted at global markets. They have paid relatively little attention to the social and cultural aspects of markets at regional and local levels. Yet the centre of gravity of the industry is now shifting to Asia and prospects for market expansion are focusing on Latin America and Africa. The evolution of mobile systems to meet the local requirements of all communities requires fresh perspectives.

Developing and deploying technologies, regulatory regimes and business models to accommodate social and cultural issues at a local level is a major long term challenge for the industry.

# Glossary

3GPP: Third Generation Partnership Project – standardisation structure producing UMTS specifications (UTRA FDD and TDD modes including TD-SCDMA) and GSM evolution (including GPRS and EDGE)

ARPU: Average Revenue Per User

BWA: Broadband Wireless Access – describes technology based on IEEE 802.x standards offering an alternative to wired ‘last-mile’ access links for broadband voice, data and video.

CDMA: Code Division Multiple Access

CDMA (IS-95): second generation mobile system using CDMA access mode

CDMA2000: 3G technologies evolved from CDMA (IS-95) – also known as CDMA MC (multi carrier). A ‘family’ of technologies, namely 1xRTT (using 1.25 MHz duplex channels), 1xEV-DO and 1xEV-DV. Multi-carrier solutions (e.g. 3xRTT) are included in principle, but not currently pursued.

EDGE: Enhanced Data rates for Global Evolution – enhanced radio modulation method for GSM and TDMA (IS-136) networks to achieve significantly higher data rates. Combines circuit mode and data.

GPRS: General Packet Radio Service – evolution of GSM for packet data transmission – operates in the GSM frequency bands

GSM: Global System for Mobile Communication; second generation mobile system originally developed in Europe, using a TDMA access radio interface combined with frequency division multiple access (FDMA). Oriented to voice and circuit mode data.

HSDPA: High Speed Downlink Packet Access – modulation method based on WCDMA evolution, standardised as part of 3GPP Release 5, that improves the peak data rate and throughput (dependent on radio conditions) to enhance spectral efficiency.

HSUPA: High Speed Uplink Packet Access – complementary to HSDPA, offering similar enhancements in uplink performance between terminal device and base station.

IMS: IP Multimedia Subsystem – standardised architecture enabling converged voice and data services in the mobile environment, built on Internet services, applications and protocols.

IMT-2000: ITU term for third generation mobile family

IPv6: Internet Protocol version 6 – ‘next generation’ Internet protocol overcoming limitations of IPv4 – notably limited address space – and offering other improvements in routing and network configuration.

ITU: International Telecommunication Union

OFDM: Orthogonal Frequency Division Multiplexing – coding scheme that splits signals into several narrowband channels at different frequencies. Benefits include high spectral efficiency with resistance to interference and reduced multi-path distortion.

OMA: Open Mobile Alliance – organisation facilitating global user adoption of mobile data services by ensuring interoperability across devices, geographies, service providers, operators and networks.

PSTN: Public Switched Telephone Network – ‘conventional’ telephone system based on circuit switched connections carrying voice-oriented information.

QoS: Quality of Service – measurement of transmission rates, error rates, priority, dedicated bandwidth and other parameters relating to performance of data networks.

RAN: Radio Access Network – ‘wire-free’ segment of a communications network based on radio technology that connects other devices via a standardised air interface to the main network.

SIP: Session Initiation Protocol – Application-layer signalling protocol for managing sessions with one or more participants that may include Internet multimedia conferences, Internet telephony, presence and messaging.

TD-CDMA: Time Division-Code Division Multiple Access – a hybrid access technology combining TDMA and CDMA, as applied for the TDD Mode of UMTS, and using a 5 MHz frequency band.

TDMA: Time Division Multiple Access – radio access mode used for second generation mobile (GSM, PDC, IS-136)

TDMA (IS-136): second generation mobile system used mainly in US (formerly known as D-AMPS)

TD-SCDMA: Time Division-Synchronous Code Division Multiple Access – a hybrid access technology combining TDMA and SCDMA, a CDMA scheme that contains an additional mechanism for synchronisation, using a 1.6 MHz channel.

UMA: Unlicensed Mobile Access – provides seamless access to mobile services via various unlicensed spectrum technologies.

UMTS: Universal Mobile Telecommunications System – 3G system standardised by ETSI under 3GPP along with other regional standards organisations

WCDMA: Wideband CDMA – also known as CDMA DS (Direct Sequence) within the IMT-2000 framework – is the radio access technology for one of the UMTS access modes (UTRA FDD) using 5 MHz duplex channels. Combines circuit mode and packet mode initially.

WiFi: Commonly used synonym for WLAN

WiMAX: describes broadband wireless networks offering fixed, nomadic and portable access based on the IEEE 802.16 standard.

WLAN: Wireless Local Area Network – generic term for different high speed radio access modes in the 2.4 GHz to 5 GHz frequency bands.

For latest information on 3G/UMTS launches, please visit [www.umts-forum.org](http://www.umts-forum.org)



# Annex: 3GPP and Technical Specifications for 3G/UMTS

The 3rd Generation Partnership Project ([www.3gpp.org](http://www.3gpp.org)) is a collaboration agreement that brings together a number of telecommunications standards bodies.

The term '3GPP specification' covers all GSM (including GPRS and EDGE) and WCDMA specifications. Each 3GPP Release provides mobile operators and equipment manufacturers with a stable reference platform to build networks and terminal equipment. The earliest commercial 3G/UMTS networks were based on Release 99. This first Release was essentially a consolidation of the underlying GSM specifications and the development of the new UTRAN radio access network. Release 99 also laid the foundations for future high-speed traffic transfer in both circuit switched and packet switched modes that have since been developed in subsequent Releases.

This annex provides an overview of the key Features of Release 5 that were 'frozen' in September 2003. In this context, a Feature is defined as new or substantially enhanced functionality which represents added value to the existing system. A Feature should normally embody an improved service to the customer and/or increased revenue generation potential to the supplier.

## 3GPP Release 5: Overview of key Features

- Improvements of radio interface, including TDD base station classification and enhancement on the DSCH (Downlink Shared Channel) hard split mode
- Radio Access Network improvements
- Release 5 evolutions of the transport in the UTRAN
- LCS (Location Services) enhancements
- Security enhancements: Network Domain Security
- High Speed Downlink Packet Access (HSDPA): Architecture, AMC, adaptative modulation and coding
- Intra domain connection of RAN nodes to multiple core network nodes ('IU flex')
- UTRAN sharing in connected mode
- IP Multimedia Core Network Subsystem (IMS)
- Extended transparent end-to-end packet switched mobile streaming applications ('extended streaming')
- OSA (Open Service Access) improvements
- CAMEL (Customised Applications for Mobile network Enhanced Logic) phase 4
- Mobile Execution Environment (MExE) enhancements
- Wideband Adaptative Multi Rate Codec
- Terminal interfaces - local model enhancements
- (U)SIM toolkit enhancements
- Charging and Operation, Administration, Maintenance and Provisioning (OAM&P)
- GSM/EDGE Radio Access Network (GERAN) enhancements
- End-to-end QoS
- Messaging enhancements, including MMS and EMS
- Service change and Unrestricted Digital Information (UDI) fallback
- Handling of early user equipment

Continuing work in 3GPP will see other Features incorporated into future Releases.

Key features of Release 6 that were finalised in December 2004 include:

- IMS Phase 2, including:
  - Interworking: IMS and Circuit Switched networks; IMS and non-IMS networks; Access Independent IMS (with 3GPP2)
  - Group Management (Presence, Messaging, Conferencing)
  - IMS Charging
  - Lawful interception
- MBMS (Multimedia Broadcast Multicast Service)
- Enablers for services including PoC (with OMA)
- WLAN interworking scenarios
- Push services
- Speech recognition and speech enabled services
- Digital Rights Management (with OMA)

Other currently incomplete work items scheduled for likely inclusion in Release 6 (March/June 2005) include:

- FDD Uplink Enhancements ('EDCH')
- AMR-WB+ (Adaptive Multi-Rate Wideband Codec extension) for high audio quality
- Packet streaming (PSS)
- Generic User Profile
- Presence
- Access Class Barring & Overload Protection
- Charging management for WLAN, PoC etc

Other Features currently planned for later Releases include:

- MIMO (Multiple Input Multiple Output) antennas
- 7.68 Mcps TDD
- GERAN conversational services
- Other enhancements including IMS, LCS, video and voice services

For more information on 3GPP specifications, including detailed status of Release 6 and later Releases, please see:

[www.3gpp.org/specs/specs.htm](http://www.3gpp.org/specs/specs.htm)





U M T S  
F o r u m

UMTS Forum, Russell Square House, 10 -12 Russell Square, London, WC1B 5EE, United Kingdom  
Tel: +44 (0) 20 7331 2020 Fax: +44 (0) 20 7331 2040

e-mail: [info@umts-forum.org](mailto:info@umts-forum.org) Web: [www.umts-forum.org](http://www.umts-forum.org)